

# Typical Drawing Layouts for Building Applications

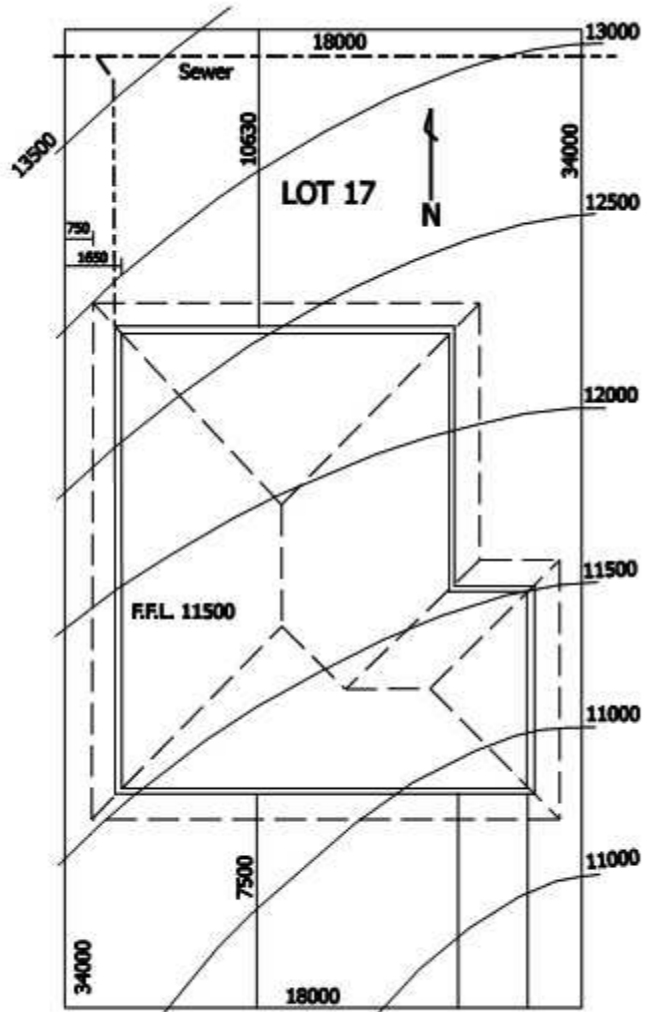

ROAD NAME  
Site Plan 1:200

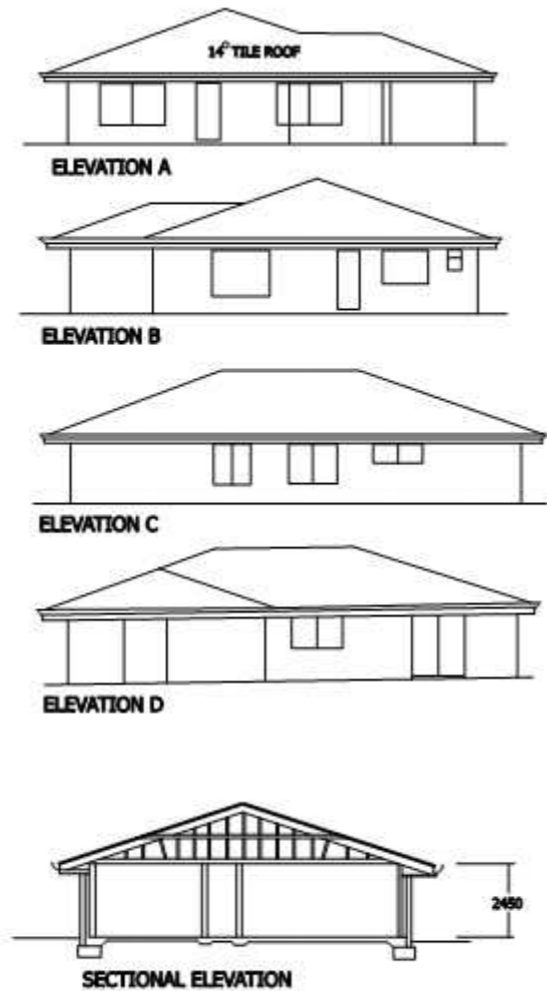

SECTIONAL ELEVATION

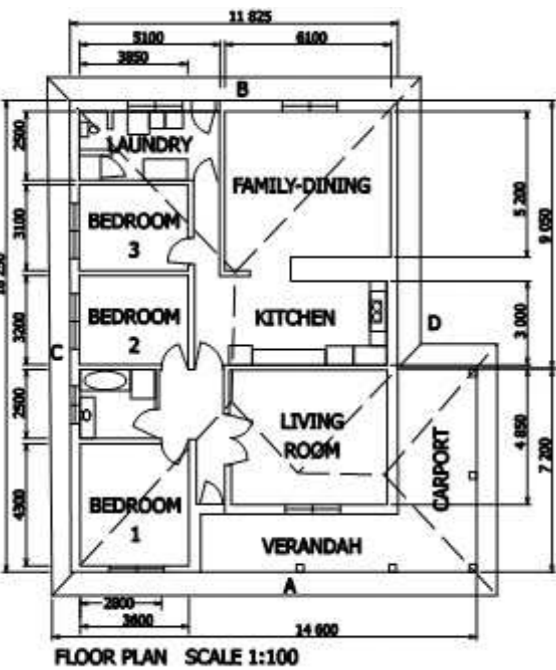

FLOOR PLAN SCALE 1:100

Typical Layout for a New Dwelling

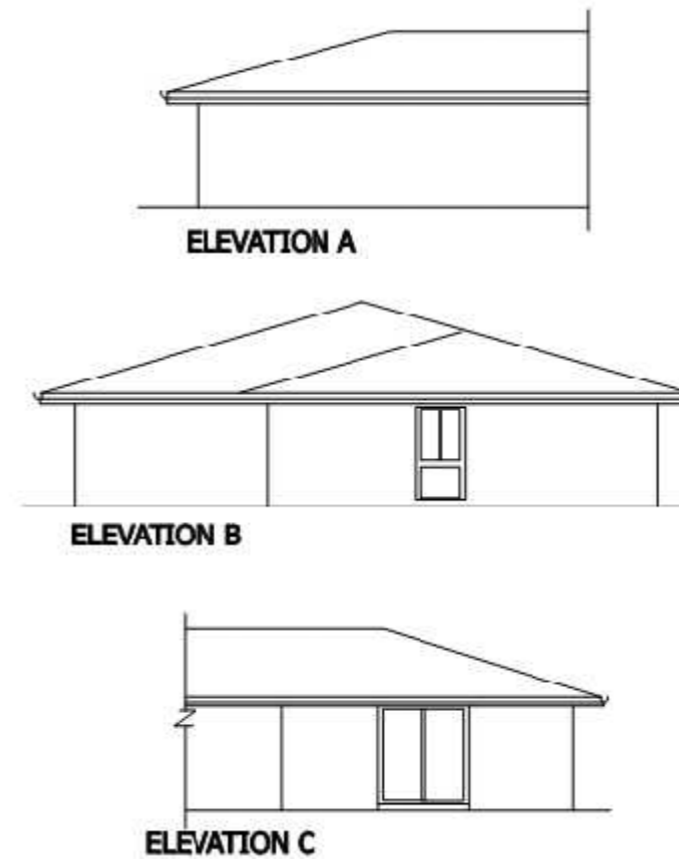

ELEVATION C

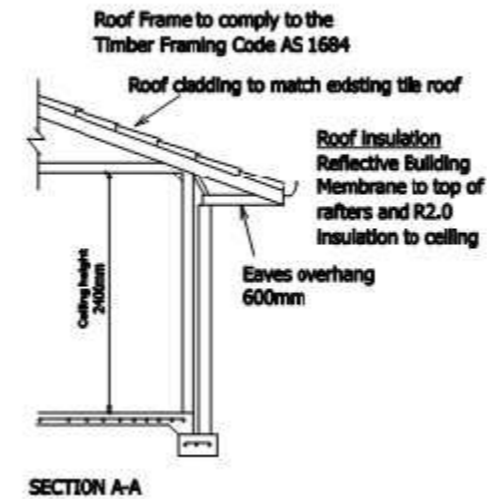

SECTION A-A

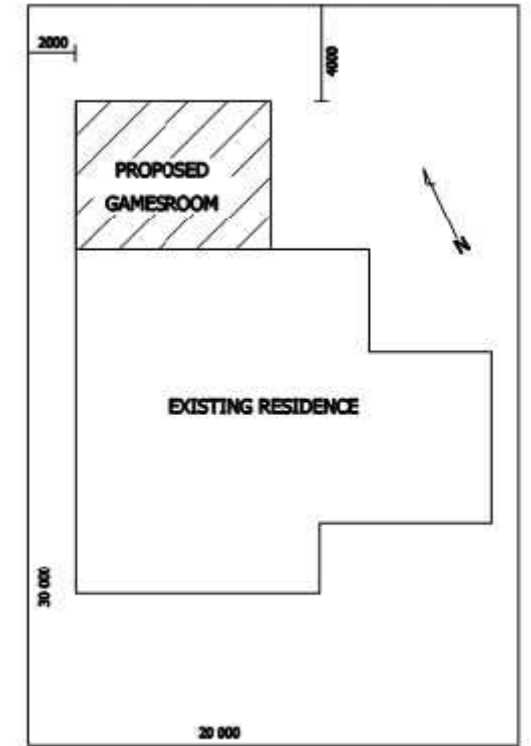

ROAD NAME Site Plan 1:200

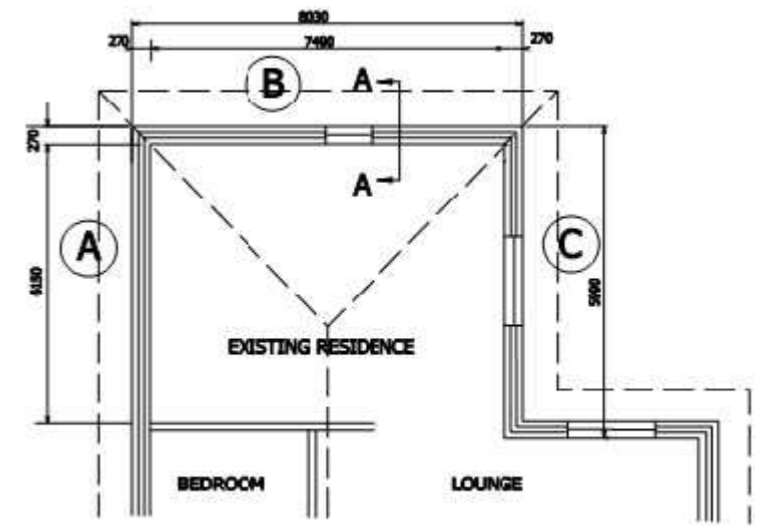

FLOOR PLAN SCALE 1:100

Typical Layout for an Addition